



SERVICE MANUAL

PRINT No.87595115A

TX130-40 turbo

TX130-43 turbo

TX130-45 turbo

TX140-43 turbo

TX140-45 turbo

TX170-45 turbo

COMPANY POLICY

Company policy, which is one of continuous improvement, reserves the right to make changes in design and specification, without notice and without obligation to modify units previously built.

All data given in this book is subject to production variations. Dimensions and weights are approximate only and the illustrations do not necessarily show machines in standard condition. For exact information about any particular machine please consult your dealer.

PARTS AND ACCESSORIES

Genuine parts and accessories have been specifically designed for these machines.

We would like to point out that “non-genuine” parts and accessories have not been examined and released by Builder. The installation or use of such products could have negative effects upon the design characteristics of your machine, and thereby affect its safety. The Builder is not liable for any damage caused by the use of “non-genuine” parts and accessories.

MODEL CODES

The complete range of telescopic handlers (Telehandler) described in this manual is identified in the text by reference to the maximum extension of the telescopic arm.

The vehicles listed below may not be available in all countries or markets, therefore for the latest information consult your authorised dealer.

Model	LM1340	LM1343	LM1345	LM1443	LM1445	LM1745
Stabilisers	no	small	large	small	large	large
Engine	82 kW (110 CV - 118 HP) Turbo Aftercooler					
Max. lifting height (m)	12.300	12.450	12.450	13.550	13.550	16.600
Max. capacity (kg) at 500 mm from fork stop	4000	4300	4500	4300	4500	4500
Capacity at max. height (kg)	2600	3600	4000	3000	3600	2500
Extension at max. height (m)	1.200	0.500	0.000	0.500	0.300	1.000
Max. longitudinal extension (m)	8.650			9.330		12.540
Capacity at max. extension (kg)	700	1700	1800	1400	1500	450
Weight (kg)	10480			10780		11760
Length (m)	5.850			6.070		6.135

Service manual TX130-40 turbo/TX130-43 turbo/TX130-45 turbo TX140-43 turbo/TX140-45 turbo TX170-45 turbo TELESCOPIC HANDLERS

GENERAL LIST OF CONTENTS

SECTION 00 - GENERAL

Description	Page
General instructions	1
Safety rules	3
Product identification	6
Environmental considerations	9
Maintenance techniques	10

SECTION 10 - ENGINE

Description	Page
Coding of engines of origin	3
Main engine specifications	4
General engine specifications	5
Generalities	7
Description of engine main mechanical components	13
Lubrication	24
Cooling	29
Mechanical injection fuel system	31
Injection assembly	33
Removal of the engine transmission group from the vehicle	43
Engine overhaul on bench	46
Replacement of injectors	98
Valve clearance	100
Timing setting	101
Timing of injection pump	102
Electrical components	103
Troubleshooting	104
Tooling	108
Mounting plays	112

SECTION 21 - POWERSHIFT GEARBOX

Description	Page
Gearbox assembly	5
Idler gear case assembly	7
Gearbox operation	8
Transmission and Hydraulic oil circuit diagrams	15
Modulation valve operation	31
Torque converter and heat exchanger hydraulic oil circuit	34
Troubleshooting procedures	37
Pressure testing clutch and high pressure circuit	38
Pressure testing torque converter and cooler circuit	39
Check points	40
Assembly instructions	42
Overhaul	45
Special tools	104

SECTION 25 - FRONT AXLE

Description	Page
Specifications	1
Description	2
Operation	3
Troubleshooting	4
Wheel toe-in check	5
Component overhaul	5
Front axle removal procedure	6
Front axle overhaul	7
Axle drive pinion bearing adjustment	52
How to install and adjust the axle drive pinion	54
Front drive shaft	57

**Thanks very much for your reading,
Want to get more information,
Please click here, Then get the complete
manual**

JustClickHere 

NOTE:

**If there is no response to click on the link above,
please download the PDF document first, and then
click on it.**

**Have any questions please write to me:
admin@servicemanualperfect.com**

SECTION 27 - REAR AXLE

Description	Page
Specifications	1
Description	2
Operation diagram	3
Component overhaul	5
Rear axle removal procedure	5
Overhaul	6
Special tools	7

SECTION 33 - BRAKES

Description	Page
Power brakes	2
Parking brake	3
Brake disc adjustment	6
Troubleshooting	7
Brake disc replacement	8

SECTION 35 - HYDRAULIC SYSTEM

Description	Page
Technical data	2
Description and operation	3
Steering system hydraulic circuit	3
Steering valve	4
Telescopic boom hydraulic circuit	6
Component operation	11
Hydraulic pump	11
Hydraulic scheme	11
Delivery side divider valve	11
Pressure reducing valve	13
Front loader controls	15
Power steering (OSPQ)	19
Telescopic boom distributor	21
Auxiliary controls distributor	24
Cylinders	25
Arms	35
Boom removal	35
Working platform	61
Procedure for the calibration of the personnel carrier platform electronic controller	65
Special tools	71

SECTION 55 - ELECTRICAL SYSTEM

Description	Page
Chapter 1 – Electrical system general	
Electrical equipment specifications	1
Electrical system and fuse	2
Controls and instruments	6
Use of the tip-over prevention system	16
Bulb replacement	23
Protecting the electrical systems during charging or welding	26
Starting the machine using jump leads	27
Temporary wiring repair	28
Electrical system general fault finding	30
Working platform	31
Special tools	46
Chapter 2 – Circuit diagrams	
List of connectors	48
List of components	49
How to use the circuit diagrams	50
Diagram 1: Starting/Recharge/Warning lights/Indicator	51
Diagram 2: Transmission	55
Diagram 3: Wheel alignment/Hydraulic solenoids/Brake system	57
Diagram 4: Arm control	59
Diagram 5: Stabiliser	61
Diagram 6: Lights/Windscreen wiper	63
Diagram 7: Work lamps/Roof beacon light	65
Diagram 8: Tilting prevention system/Roof wiper	67
Diagram 9: Sound system heating/Electric socket/Roof lamp	69
Diagram 10: Air conditioner	71
Chapter 3 - Wiring list	
Instrument panel wiring	75
Cab wiring	79
Front wiring	80
Rear wiring	81
Engine wiring	82

GENERAL INSTRUCTIONS

IMPORTANT NOTICE

All maintenance and repair interventions listed in this Manual must be performed exclusively by the Service Network of the Manufacturer, complying strictly with the indications herein and using, when required, the prescribed special tools.

Whoever performs service operations described herein without complying strictly with the instructions becomes solely responsible for any consequential damage that could occur.

ADJUSTING SHIMS

For each adjustment select the adjusting shims, measuring them one by one with a micrometer and adding together subsequently, the values measured. Do not rely on the measurement of the entire pack, that could be wrong, or the nominal value indicated on each ring.

SEALS FOR ROTATING SHAFTS

For correct installation of the seals for rotating shafts, please comply with the following precautions:

- prior to installation, keep the seals soaking for at least half an hour in the same oil they are going to seal;
- clean thoroughly the shaft and make sure that its working face is undamaged;
- direct the sealing lip toward the fluid; in the event the lip is of the hydro dynamic type, the grooves must be directed so that, in relation to the rotating direction of the shaft, they tend to return the fluid toward the inside of the sealing device;
- smear the sealing lip with a film of lubricant (oil to be preferred to grease) and fill with grease the gap between sealing lip and dust lip in twin lip seals;
- insert the seal in its seat, pressing it with a punch with a flat face; never strike it with a hammer or mallet;
- when pressing in the seal, make sure that it is inserted perpendicularly in relation to the seat and, once in position, make sure that, when required, it contacts the shoulder;
- to prevent the sealing lip of the seal being damaged by the shaft, insert appropriate protection during the installation of the two parts.

“O-RING” TOROIDAL SEALS

Lubricate O-rings before inserting them in the relevant seats to prevent them becoming twisted and rolled during installation, thus jeopardising their sealing capacity.

SEALING COMPOUNDS

Mating surface marked X must be smeared with a sealing compound recommended by the Manufacturer or an adequate equivalent.

Prior to applying the compound, prepare the surfaces in the following manner:

- remove all possible scaling with a metal brush;
- degrease the surfaces thoroughly using the degreasing agent recommended by the Manufacturer or an adequate equivalent.

BEARINGS

When installing bearings, it is recommended to:

- warm them up to 80° – 90 °C (176 – 194 °F) before installing them on the relevant shafts;
- cool them down before inserting them in the relevant seats with an outer fitting.

SPLIT PINS

When installing split pins, make sure that the cut is pointing in the direction of the load on the pin. On the other hand, spiral elastic pins do not require any installation orientation.

NOTES ON SPARE PARTS

Use genuine **spare parts guaranteed by the Manufacturer** only.

Genuine spare parts are the only ones ensuring the same quality, the same life and the same safety as the originally mounted parts, since they are the same as the ones installed in production.

Only genuine parts from the manufacturer ensure this guarantee.

Orders for spare parts must include the following indications:

- model of the vehicle (commercial designation) and serial number;
- type and number of the engine;
- part number for the item ordered, as provided by the "Microfiches" or the "Spare Part Catalogue", on which the order is based.

NOTES ON TOOLING

The tooling that the Manufacturer recommends and illustrates in this Manual is:

- studied and designed specifically for servicing vehicles of this range;
- required to ensure a reliable repair;
- accurately developed and inspected to provide effective and long lasting working.

You are also reminded that correct tooling allows you to:

- to operate under optimised technical conditions;
- to achieve the best results;
- to save time and effort;
- to work in safer conditions.

WARNING

The wear limits provided for some items must be considered as recommended values, but not absolutely binding. The indications "front", "rear", "right", "left" refer to different parts as seen seating from in the operator's seat oriented in the normal travel direction of the vehicle.

HOW TO MOVE A VEHICLE WITHOUT BATTERIES

The cables of the external power supply must be connected exclusively to the respective terminals of the positive and negative cables of the vehicle, using efficient clamps providing adequate and safe contact. In the event it is necessary to check the operation of the electrical system of the vehicle, do it exclusively with the power supply connected. At the end of the inspection, disconnect all actuators and deactivate the power supply before disconnecting the cables.

SAFETY RULES

PAY ATTENTION TO THIS SYMBOL



This alert symbol announces important messages involving your safety. Read carefully the safety instructions listed and follow the precautions recommended to avoid potential risks and to safeguard your health and your safety. You will find this symbol in the text of this Manual with the following key words:



WARNING - Cautions intended to avoid improper repair interventions involving potential consequences for the safety of the personnel performing the repairs.

DANGER - These warnings qualify specifically potential dangers for the safety of the operator or other persons directly or indirectly involved.

AVOID ACCIDENTS

Most accidents, whether they occur in workshop, on the farm, at home or on the road, are caused by the failure of some individuals to follow simple and fundamental safety rules and precautions. For this reason **MOST ACCIDENTS CAN BE PREVENTED** by recognising the real cause and doing something about it before the accident occurs.

Regardless of the care used in the design and construction of any type of equipment, there are many conditions that cannot be completely safeguarded against without hindering reasonable accessibility and efficient operation.

A careful operator is the best insurance against an accident.

The complete observance of one simple rule would prevent many serious accidents.

DANGER. Never attempt to clean, lubricate or maintain a machine while it is in motion.

SAFETY RULES

SAFETY RULES

- ◇ Read and heed all safety rules before any intervention.
- ◇ Do not wear rings, wristwatches, jewellery, and loose or hanging apparels, such as ties, torn clothing, scarves, unbuttoned or unzipped jackets that can catch on moving parts. Wear proper safety equipment as recommended for the job. Examples: hard hat, heavy gloves, ear protection, safety glasses or goggles, reflector vests, respirator. Consult your employer for specific safety equipment requirements.
- ◇ Do not perform any service operation on the machine with a person seated in the operator's compartment, unless he is an authorised oper-

ator co-operating in the operation to be performed.

- ◇ Never attempt to operate the machine or its tools from any position other than seated in the operator's seat.
- ◇ Never perform any intervention on the machine with engine running unless this is prescribed.
- ◇ Cut-off the engine and make sure that all pressures in the hydraulic systems are released before removing caps, covers, valves etc.
- ◇ All service interventions must be performed with the utmost care and attention.
- ◇ Shop and/or field service platforms or ladders must be constructed and maintained in accordance with local and national regulations.
- ◇ Disconnect the batteries and tag all controls to signal that an intervention is in progress. Block the machine and all equipment that must be lifted.
- ◇ Do not check nor refill fuel tanks, as well as batteries, nor use starting fluid while smoking or near open flames since these fluids are flammable.
- ◇ Brakes are inactive when manually released for service interventions. Under such circumstances it is necessary to maintain the control of the machine using appropriate blocks or similar devices.
- ◇ The fuel-filling nozzle must be kept constantly inside the filling neck. Keep this contact from the beginning to the end of the fuelling operation to avoid the possibility that sparks due to static electricity are generated.
- ◇ Use only designated towing or attaching points. Use care in making attachments. Make sure pins and/or locks are secure before pulling. Stay clear of drawbars, cables or chains under load.
- ◇ To move a disabled machine, use a trailer or a low-boy, if available.

- ◇ To load/unload a machine from transporter, choose a level surface ensuring firm support to the wheels of truck or trailer. Anchor the machine securely to the bed of truck or trailer and block wheels or tracks with appropriate wedges.
 - ◇ Use only approved grounded auxiliary power sources for heaters, chargers, pumps and similar equipment to reduce the hazards of electrical shocks.
 - ◇ Lift and handle heavy parts with a lifting device of proper capacity.
 - ◇ Beware of bystanders.
 - ◇ Never pour gasoline or diesel fuel into open, wide and low containers.
 - ◇ Never use gasoline, solvent or other flammable fluid to clean parts. Use exclusively qualified, non-flammable, non-toxic commercial solvents.
 - ◇ When using compressed air for cleaning parts, use safety glasses with side shields or goggles.
 - ◇ Limit pressure to 2.1 bar, in accordance with local and national regulations.
 - ◇ Do not run the engine in closed areas without proper ventilation to remove deadly exhaust fumes.
 - ◇ Do not smoke or permit any open flames or spark near when re-fuelling or handling flammable materials.
 - ◇ Do not use an open flame as a light source to look for leaks or for inspection anywhere on the machine.
 - ◇ Move with extreme care when working under the machine, its attachments and or on or near them. Always wear protective safety equipment as required, such as hard hat, goggles, safety shoes, ear plugs.
 - ◇ When performing operations requiring running of the engine, have a qualified operator in the operator's seat at all times with the mechanic on sight. Place the transmission in neutral and set the brakes and safety lock.
 - ◇ For field service, move machine to level ground, if possible, and block it. If work on an incline is absolutely necessary, first block machine and its attachments securely, than move it to level ground as soon as possible with a certain margin of safety.
 - ◇ Do not trust worn and /or kinked chains and cables: do not use them for lifting or pulling operations. To handle them, always use heavy gloves.
 - ◇ Be sure chains and cables are anchored and the anchor points are strong enough to handle the expected load. Keep exposed personnel clear of anchor points and cables or chains. No bystanders are allowed near the hooking points, chains or cables.
 - ◇ Keep the area where maintenance operations are performed CLEAN and DRY. Eliminate immediately all water and oil spillages.
 - ◇ Do not pile up oily or greasy rags; they represent a fire hazard. Store in a closed metal container.
- Before starting machine, check, adjust and lock the operator's seat for maximum comfort and control of the machine. Be sure exposed personnel in the area of operation are clear of the machine before moving it or its attachments. Sound the horn.
- ◇ Do not carry loose objects in pockets that might fall unnoticed into open compartments.
 - ◇ Wear proper protective equipment such as safety goggles or safety glasses with side shields, hard hat, safety shoes, heavy gloves when metal or other particles are apt to fly or fall.
 - ◇ Wear welders protective equipment such as dark safety glasses, helmets, protective clothing, gloves and safety shoes, when welding or burning. Wear dark safety glasses near welding zones. **DO NOT LOOK AT ARC WITHOUT PROPER EYE PROTECTION.**
 - ◇ Steel cables are frayed after prolonged use; always wear appropriate protections (heavy gloves, goggles etc.).
 - ◇ Handle all parts carefully. Keep hands and fingers away from structures, gears or moving parts. Use and wear always the appropriate protections, such as safety goggles, gloves and safety shoes.

STARTING

- ◇ Do not run the engine in closed areas without proper ventilation to remove deadly exhaust fumes.
- ◇ Do not place head, body, limbs, feet, hands or fingers, near rotating fans or belts. Be especially alert near pusher fans.

ENGINE

- ◇ Loosen the radiator cap very slowly, to release pressure from the system, before removing it. All coolant level top-ups must be performed with engine inoperative or at low idle, if warm
- ◇ Do not run engine when refuelling and use care if the engine is hot due to the increased possibility of a fire if fuel is spilled.
- ◇ Never attempt to check or adjust fan belts when engine is running. Do not adjust engine fuel pump when machine is moving.
- ◇ Never lubricate the machine with engine running.

ELECTRICAL SYSTEM

- ◇ Should booster batteries be used, remember to connect both ends of the booster cables in the proper manner (+) with (+) and (-) with (-). Avoid short-circuits of the terminals. Follow thoroughly the instructions of this Manual. Avoid short circuiting the terminals. **BATTERY GAS IS HIGHLY FLAMMABLE.** Leave battery box open to improve ventilation when recharging batteries. Never check charge by placing metal objects across the posts. Keep sparks or open flames away from batteries. Do not smoke near battery to guard against the possibility of causing an explosion.
- ◇ Before any intervention, make sure that there are no fuel or electrolyte leakages; eliminate them before proceeding with further work.
- ◇ When recharging batteries in closed ambient, make sure that there is appropriate ventilation to prevent possible accidental explosions due to the accumulation of gases generated during the recharge.
- ◇ Before any intervention, make sure that the main switch is OFF.

HYDRAULIC SYSTEM

- ◇ Fluid escaping under pressure from a very small hole can be almost invisible and can have sufficient force to penetrate the skin. Use a piece of cardboard or wood to search for suspected pressure leaks. do not use hands. If injured by escaping fluid, see a doctor at once. Serious infection or reaction can develop if proper medical treatment is not administered immediately.
- ◇ In case pressures must be measured, use instruments of adequate capacity. Always follow the recommended procedures.

WHEELS AND TYRES

- ◇ Make sure that the inflation pressure of the tyres is according to the specifications issued by the Manufacturer and check it periodically.
- ◇ Should the pressure be changed, stand on the side of the tyre at a safe distance.
- ◇ Pressure check operations must be performed with unloaded machine and cold tyres. Never use reconditioned tyre rims, since eventual weldings, heat-treatments or repairs not performed correctly can weaken the wheel, thus causing subsequent damages or dangers.
- ◇ Do not perform torch cutting or welding operations on rims with inflated tyres installed.
- ◇ Before operating on tyres, block all wheels, front and rear. After jacking the machine, block it with stands according to current safety rules and regulations.
- ◇ Before removing objects from the tyre tread, deflate it.
- ◇ Never inflate tyres with flammable gas; explosions and serious bodily injuries may result.

REMOVALS AND INSTALLATIONS

- ◇ Lift and handle all heavy parts with lifting devices of adequate capacity. Make sure that the parts are attached to lifting devices are properly slinged. Use the lifting eyes provided. Beware of persons in the vicinity.
- ◇ Handle all parts carefully. Keep hands and fingers away from structures, gears or moving parts. Use and wear always the appropriate protections, such as goggles, gloves and safety shoes.
- ◇ Prevent chains and cables from kinking. To handle them, always use heavy gloves.

PRODUCT IDENTIFICATION

The Telehandler and its main components are identified by various numbers and letters providing its identification by the Service network. The following information gives the location of the identification plates, of the numbers stamped on the machine and various examples of what can be found on the machine.

VEHICLE SERIAL NUMBER

The serial number is stamped on the front part of the machine, on the upper side of the main frame, right side.

NOTE: *The serial number and the identification number of the components can be requested by the Dealer when Spare Parts are ordered or interventions are required. These numbers are also required as help in identifying the machine in the event of theft. Keep them in a safe place.*

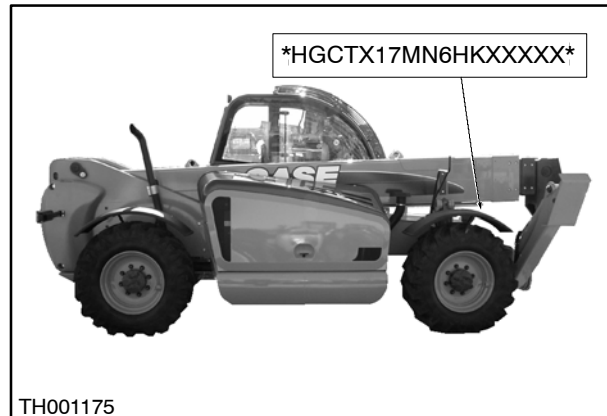

TH001175

1

VEHICLE IDENTIFICATION PLATES

The vehicle identification plate is located on the left side of the seat location. Record here below the data for your machine.

TECHNICAL TYPE/MODEL _____

SERIAL NO. OF VEHICLE _____

YEAR _____

CASE		CNH FRANCE S.A. Rue des Meuniers 60330 LE PLESSIS-BELLEVILLE (FRANCE)	
Model/Type _____			
Approval/Homologation n° _____			
Product Identification Number		☆	☆
Total permissible mass	Kg	Engine power	kW
Permissible front axle load	Kg	Year of construction	
Permissible rear axle load	Kg	CE	
Permissible towable mass	Kg		
○ 87317504			

TH001172

2

ENGINE IDENTIFICATION

The engine identification information is located on the left-hand side of the engine block. Record the information below for quick reference in case of necessity.

MODEL No. _____

SERIAL No. _____

DATE CODE _____

CNH CNH U.K. LIMITED	
ENGINE TYPE	F4GE0484G*D600
ENGINE FAMILY	F4GE23B00C
SERIAL NUMBER	XXXXXXXXXX
EEC APPR. N°	e3*97/68FA*2001/63*1006
(E3)	85R-021035
	24R-031034

TH001141

3

CNH CNH U.K. LIMITED IMPORTANT ENGINE INFORMATION			
EPA family	SNHXL06,7DTA	Model	F4GE0484G*D
Date of MFG (mo yr)	09	05	
Displac.	274 cu. in.	Adv. H. P.	110@2200 r. p. m.
Idle speed	950 r. p. m.	Fuel rate @ adv. pow.	83 mm ³ /Str.
Valve lash: Intake		Exhaust	
This engine conforms to		2005 U. S. EPA & CARB regulations for large	0,010" 0,020"
non-road compression ignition engines. This engine is certified to operate on diesel fuel			
When making adjustments, set parking brake and block wheels. EMISSION CONTROL SYSTEM: EM TC SPL			
504078286			

TH001142

4

IDENTIFICATION OF FRONT AXLE

The serial number and the axle type are indicated on plate (1) located on the front side of the axle housing. Please record here below the data indicated for faster consultation when required.

AXLE TYPE _____

SERIAL NO. _____

DATE CODE _____

IDENTIFICATION OF 4x3 POWER SHIFT TRANSMISSION

The serial number and axle type is printed on the plate located on the front of the axle housing. Record the information below for quick reference in the case of necessity.

MODEL NO. _____

SERIAL NO. _____

DATE CODE _____

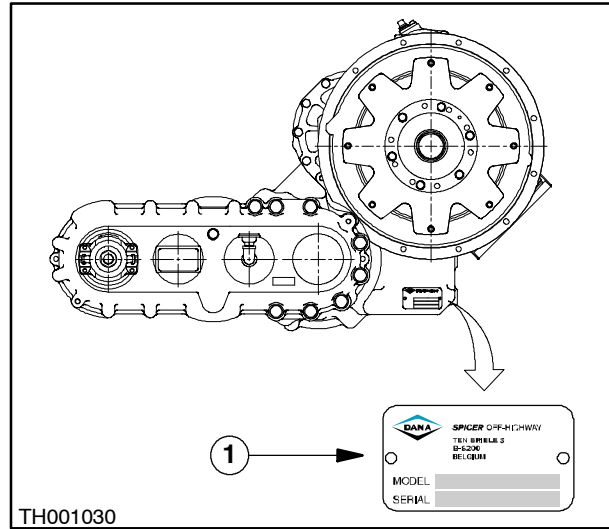

5

IDENTIFICATION OF REAR TRANSMISSION

The serial number and type is printed on the plate (1), on the lower side of the transmission. Record the information below for quick reference in the case of necessity.

AXLE TYPE _____

SERIAL NO. _____

DATE CODE _____

IDENTIFICATION PLATES IN THE CAB

The cab identification plate with serial number and details are printed on the plate to the rear left hand side of the seat. Record the serial number below for quick reference in the case of necessity.

SERIAL NO. _____

DATE CODE _____

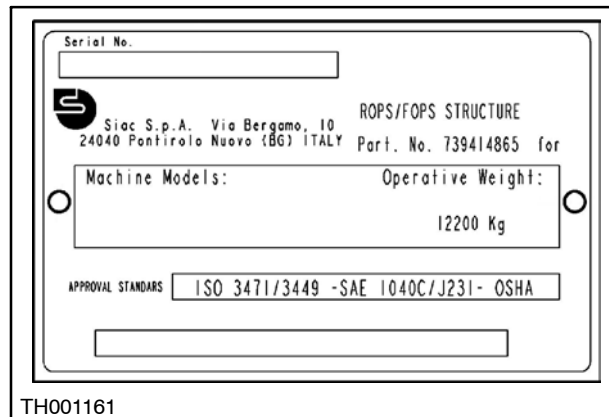

6

ENVIRONMENTAL CONSIDERATIONS

The following recommendations can be useful:

- Become familiar and make sure you have well understood the relevant legislation in effect in your country.
- In the event no regulations exist, ask for specific information with the suppliers of lubricants, anti-freeze and detergents regarding their effects on humans and the environment and how to store, handle and dispose of these substances safely.

4. Avoid spillage when draining used coolant mixtures, engine oils, transmission and hydraulic fluids, brake fluid. After draining, do not mix brake fluid or fuel with lubricants. Store them in a risk free manner until when they can be disposed of in an adequate way, in accordance with local regulations and the resources available.

5. Modern cooling mixtures, such as antifreeze and other additives, must be changed every two years. Maximum attention must be paid to prevent that they spill over the ground. They must be collected and disposed of so that do not create any danger.

6. Do not unseal air conditioning system by yourselves, since they can contain gases that must not be released into the atmosphere. The personnel specialised in air conditioners uses special equipment to charge and discharge air conditioning systems.

7. Repair at once any leakage or defect of the engine cooling system or hydraulic system.

8. Do not increase the pressure of any pressurised system, since this could cause serious problems to the components of the system.

9. Protect hoses when performing any welding, since a splash of welding materials could penetrate and burn them, causing a hole or weakening the wall with subsequent leakages of oil, coolant etc.

Useful indications

1. Do not fill tanks with inadequate canisters or dispensing pressurised systems that could cause considerable spillage.

2. In general, avoid the contact of the skin with any fuel, oil, acid, solvent etc. The majority of them contain substance dangerous for your health.

3. Modern lubricants contain additives. Do not burn contaminated fuels and/or used oils in normal heating burners.

MAINTENANCE TECHNIQUES

GENERAL NOTICES

Clean the outside of all the components prior to performing any type of repair. Dirt and abrasive dust can reduce the efficient life expectancy of a component and result in expensive repairs.

The time spent in preparing and cleaning working surfaces is giving results, making work easier and safer, and the components overhauled will be more reliable and operate better.

Use cleaning fluids proven to be safe. Some types of fluid can cause serious problems to O-Rings and irritate the skin. It is necessary to check that the solvents are suitable to clean the components and that of they are free of risks for the health of workers.

Replace O-Rings, sealing rings and seals every time they are moved. Never use old O-Rings or seals and new ones together, independently from their conditions. Always lubricate new O-Rings and seals with hydraulic oil before installing them.

When replacing components, always use the tooling required by this type of work.

HOSES AND STEEL PIPES

Always replace hoses and steel pipes when the taper end or connections are damaged.

When a new hose is installed, connect it without tightening the ends and make sure that it is routed in the correct manner, before tightening the ends. Fixtures must be tightened just enough to hold the hose without squeezing it, avoiding rubbing as well.

After replacing a hose of moving components, make sure that the hose is not disturbed by the movement of the component in any position.

Make sure that all hoses installed are not choked or bent.

If hose connections are damaged, dented, choked or leaking, decrease the flow of oil and the productivity of the relevant actuators. Connections showing signs of displacement from their original pre-pressed position must be considered as already broken, since they are going to fail or separate soon.

A hose with a ragged outer sleeve allows water to penetrate. Thus, hidden corrosion of the reinforcing wire will develop along the entire length of the hose, with the subsequent failure of the hose itself.

If a hose swells, this indicates that there is an internal leakage due to a structural failure. This condition deteriorates very quickly and causes the failure of the hose.

Clogged, squeezed, excessively tensioned or deformed hoses are generally easily subject to flow reduction, decrement of the operational speed of the fluid and the final failure of the hose.

Loose hoses move freely and must be prevented from touching each other and nearby surfaces. This causes a rubbing action shortening the useful life of the hose.

CONNECTIONS WITH FRONT SEALING O-RINGS

When repairing connections with front sealing O-Rings, please comply with the following procedures.



WARNING: NEVER DISCONNECT, NOR TIGHTEN A HOSE OR A STEEL PIPE UNDER PRESSURE. IF IN DOUBT, MOVE THE CONTROLS SEVERAL TIMES WITH THE ENGINE INOPERATIVE BEFORE DISCONNECTING A HOSE OR A STEEL PIPE.

1. Loosen the connections and separate the hose or steel pipe, then remove and eliminate the O-Rings from the connection.
2. Dip a new O-Ring in clean, hydraulic oil before installing it. Install the new O-Ring in the connection and, if necessary, hold it in its position with vaseline.
3. Install a new hose or steel pipe and tighten manually the connection holding, at the same time, the pipe still to prevent it from turning.
4. Use two wrenches to tighten the connection to the torque prescribed for its size. Please refer to the table to follow for the tightening torques.

NOTE: to ensure that a joint does not leak, it is important that the connections are neither excessively tightened nor too little.

SPECIFIC SEALING COMPOUNDS

The following sealing compounds must be used, complying with the indications provided by the Manual:

SEALANTS	COMMERCIAL NAME
Anaerobic sealant	LOCTITE 518 (liquid gasket)
RTV silicon sealant	LOCTITE SUPERFLEX 593,595 or 596 LOCTITE ULTRA BLUE 587 DOW CORNING SILASTIC 732 GENERAL ELECTRIC RTV 103 or 108
Pipe sealant	PST 592 (pipe sealant with teflon)
Locking compound for threads	LOCTITE 243/RED (sealant/locking for threads)

TIGHTENING VALUES FOR FASTENERS

Check periodically that the fasteners are properly tightened.

Based upon the tables to follow, determine the correct tightening torque when parts of the fastening components are checked, adjusted or replaced.

IMPORTANT: *DO NOT* use the values listed in the tables when the Manual indicates a different torque

or tightening procedure for a specific application. The torque values are provided for general use only.

Make sure that the threads of the fasteners are clean and undamaged.

NOTE: *use a torque wrench to tighten fasteners correctly.*

MINIMUM TIGHTENING TORQUES FOR FASTENERS

IN NEWTON-METRES (Nm)
FOR NORMAL INSTALLATION APPLICATIONS

METRIC BOLTS AND LOCK NUTS

NOMINAL DIMENSION	CLASS 5.8		CLASS 8.8		CLASS 10.9		LOCK NUT CL 8 with BOLT CL 8.8
	NOT PLATED	PLATED Zn/Cr	NOT PLATED	PLATED Zn/Cr	NOT PLATED	PLATED Zn/Cr	
M4	1.7	2.2	2.6	3.4	3.7	4.8	1.8
M6	5.8	7.6	8.9	12	13	17	6.3
M8	14	18	22	28	31	40	15
M10	28	36	43	56	61	79	30
M12	49	63	75	97	107	138	53
M16	121	158	186	240	266	344	131
M20	237	307	375	485	519	671	265
M24	411	531	648	839	897	1160	458

IDENTIFICATION

HEX SCREWS (WITHOUT NUT) AND ROUND HEAD BOLTS
CLASS 5.6 AND HIGHER

IDENTIFICATION OF THE MANUFACTURER

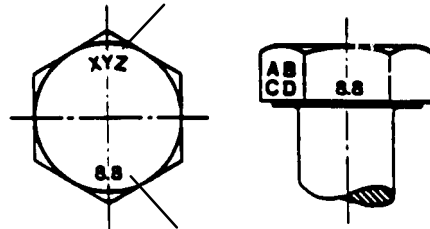

COMMERCIAL CLASS

HEX NUTS AND TIGHTENING NUTS
CLASS 05 AND HIGHER

IDENTIFICATION OF THE MANUFACTURER

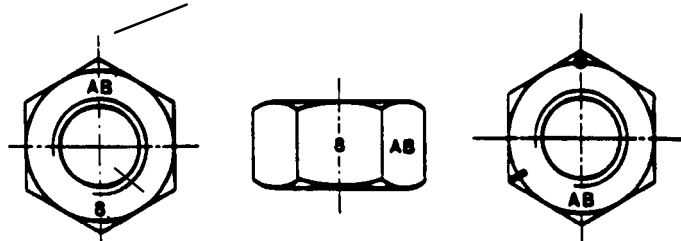

COMMERCIAL CLASS

MARKING

MINIMUM TIGHTENING TORQUES FOR FASTENERS

IN NEWTON-METRES (Nm)
FOR NORMAL INSTALLATION APPLICATIONS

INCH MEASUREMENT SCREWS AND LOCK NUTS

NOMINAL DIMENSION	GRADE SAE 2		GRADE SAE 5		GRADE SAE 8		LOCK NUTS		NOMINAL DIMENSION
	NOT PLATED OR SILVER PLATED	PLATED Zn/Cr GOLD	NOT PLATED OR SILVER PLATED	PLATED Zn/Cr GOLD	NOT PLATED OR SILVER PLATED	PLATED Zn/Cr GOLD	NOT PLATED OR SILVER PLATED	PLATED Zn/Cr GOLD	
1/4	6.2	8.1	9.7	13	14	18	6.9	9.8	1/4
5/16	13	17	20	26	28	37	14	20	5/16
3/8	23	30	35	46	50	65	26	35	3/8
7/16	37	47	57	73	80	104	41	57	7/16
1/2	57	73	87	113	123	159	61	88	1/2
9/16	81	104	125	163	176	229	88	125	9/16
5/8	112	145	174	224	244	316	122	172	5/8
3/4	198	256	306	397	432	560	217	306	3/4
7/8	193	248	495	641	698	904	350	494	7/8
1	289	373	742	960	1048	1356	523	739	1

IDENTIFICATION SCREWS (WITHOUT NUT) AND ROUND HEADED SCREWS

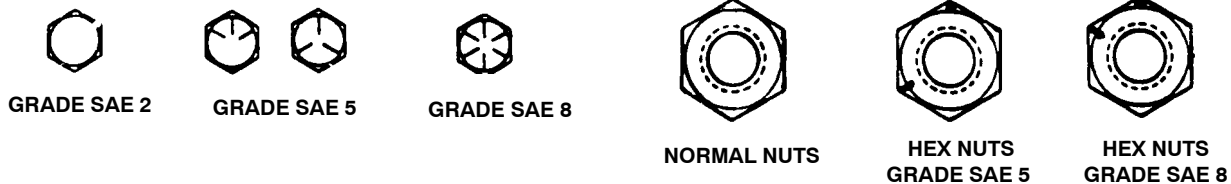

LOCK NUTS

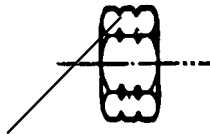

GRADE IDENTIFICATION
GRADE A: NO CUTS
GRADE B: ONE PERIMETER CUT
GRADE C: TWO PERIMETER CUTS

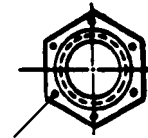

GRADE IDENTIFICATION
GRADE A: NEW MARK
GRADE B: THREE MARKS
GRADE C: SIX MARKS
THE MARKS ARE NOT COMPULSORILY
LOCATED IN THE CORNERS

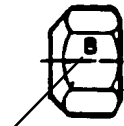

GRADE IDENTIFICATION

GRADE A. NO MARKS
GRADE B: LETTER B
GRADE C: LETTER C

GENERAL

NOTE: "The Manufacturer" pursues a policy of constant improvements, thus reserves the right to modify at any moment technical and design data, without notice, and without any obligation to modify the machines previously manufactured.

All the data provided in this Manual are subject to variations in production. Dimensions and weights are approximate and the illustrations do not necessarily show the machines in normal conditions. In order to have specific information about a determined machine, please consult an Authorised Dealer.

Model	LM1340	LM1343	LM1345	LM1443	LM1445	LM1745
Stabilisers	no	small	large	small	large	large
Engine	88 kW (110 CV - 118 HP) Turbo Aftercooler					
Max. lifting height (m)	12.300	12.450	12.450	13.550	13.550	16.600
Max. capacity (kg) at 500 mm from fork stop	4000	4300	4500	4300	4500	4500
Capacity at max. height (kg)	2600	3600	4000	3000	3600	2500
Extension at max. height (m)	1.200	0.500	0.000	0.500	0.300	1.000
Max. longitudinal extension (m)	8.650			9.330		12.540
Capacity at max. extension (kg)	700	1700	1800	1400	1500	450
Weight (kg)	10480			10780		11760
Length (m)	5.850			6.070		6.135

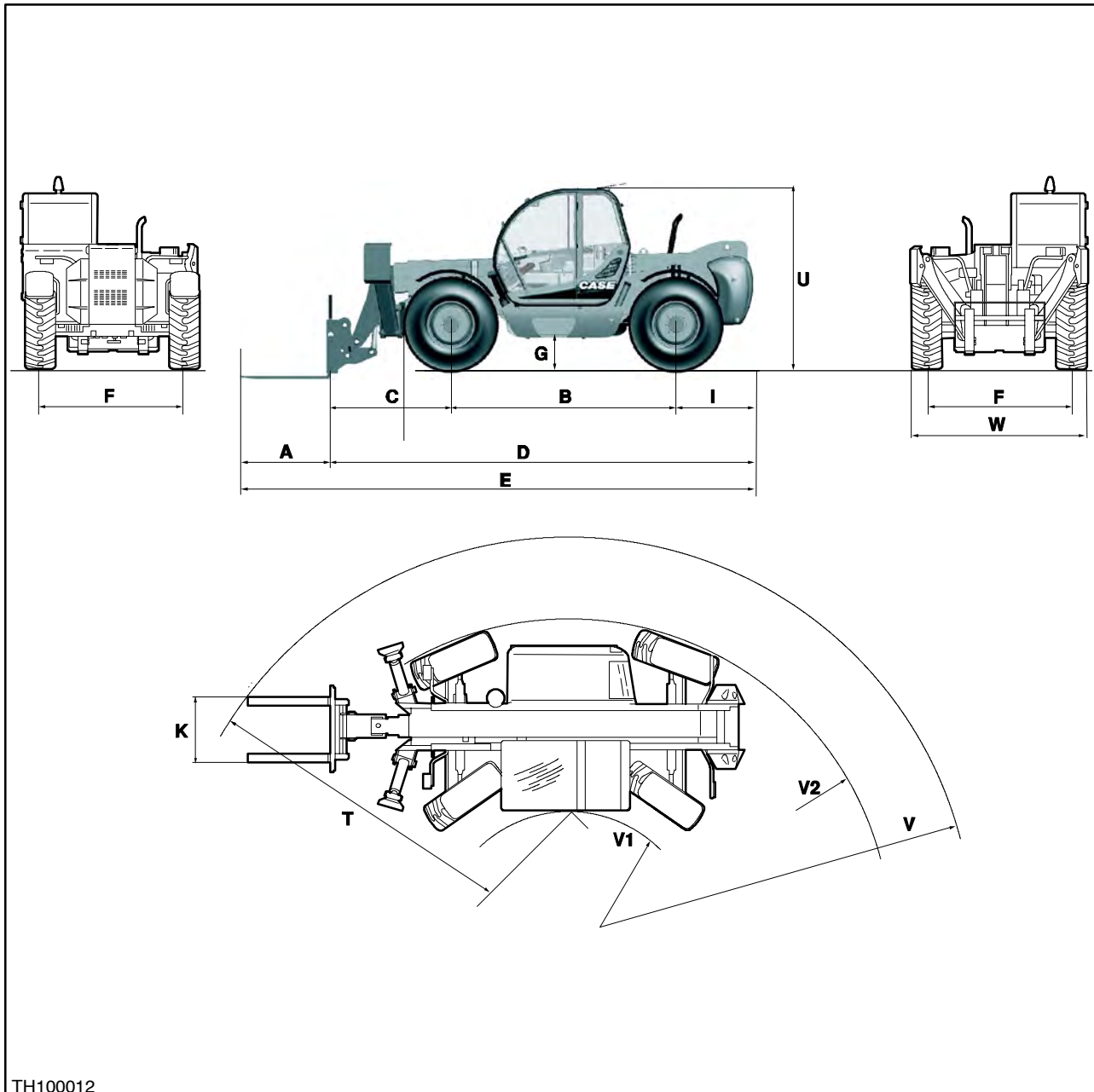

TH100012

1

TX130-40 turbo - TX130-43 turbo - TX130-45 turbo

A	1200 mm	K	1260 mm
B	3120 mm	T	4396 mm
C	1617 mm	U	2730 mm
D	5850 mm	V	5204 mm
E	7050 mm	V ₁	980 mm
F	2050 mm	V ₂	3890 mm
G	402* mm	W	2445 mm
I	1100 mm		

* Value measured with tyres 405/70x24